

VIEW ISO 1 (1 : 36)

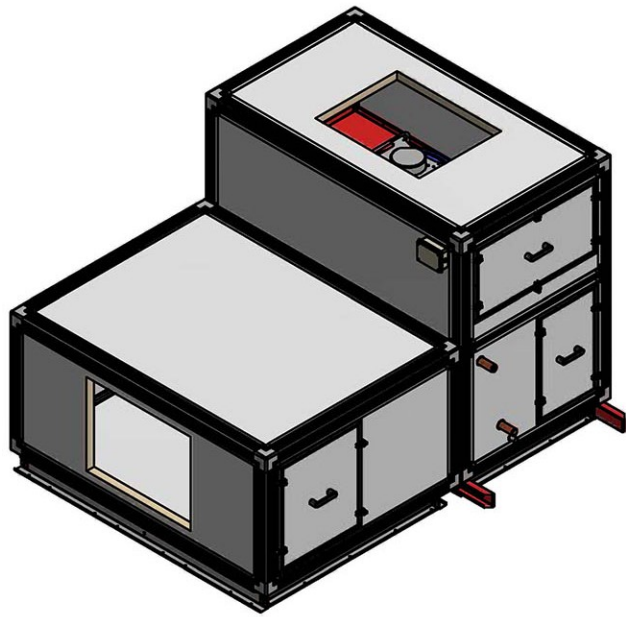

VIEW ISO 2 (1 : 36)

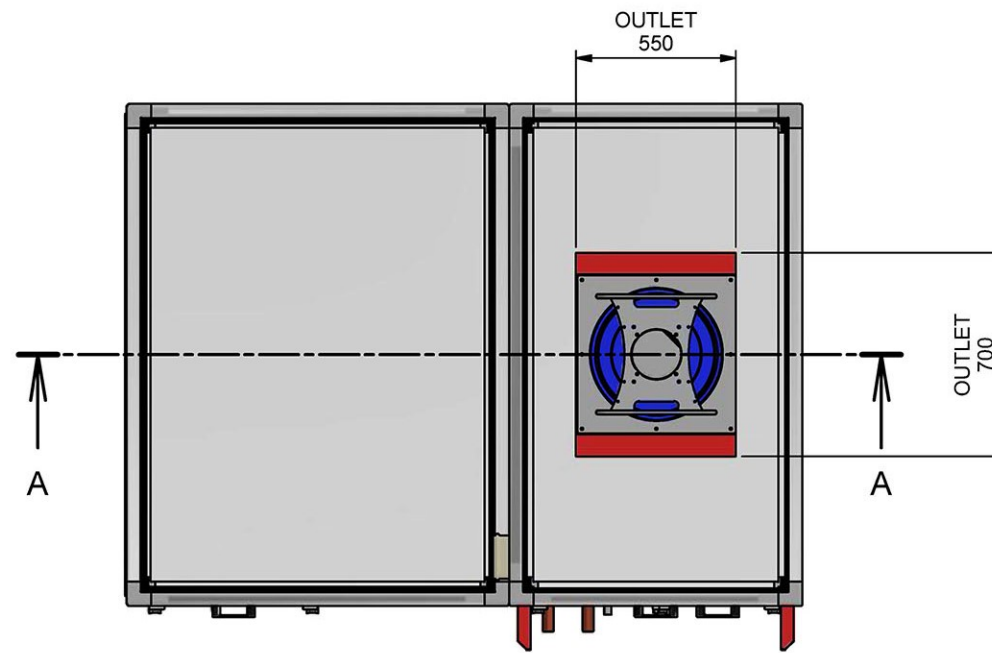
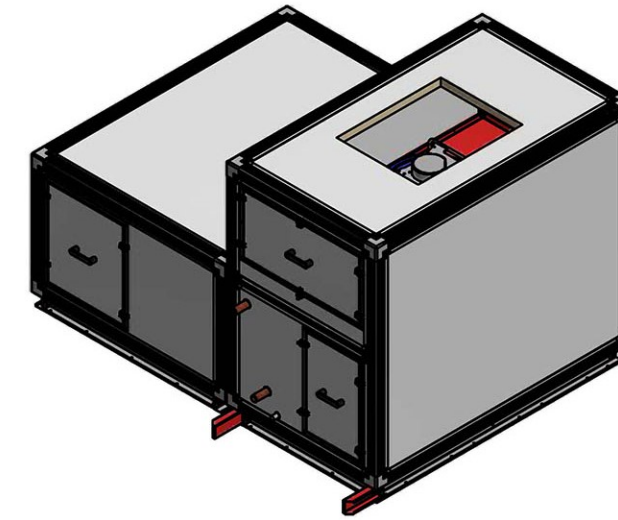

A-A (1 : 26)

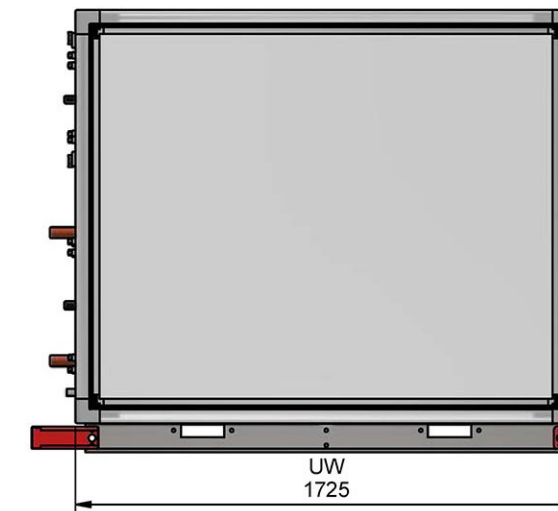
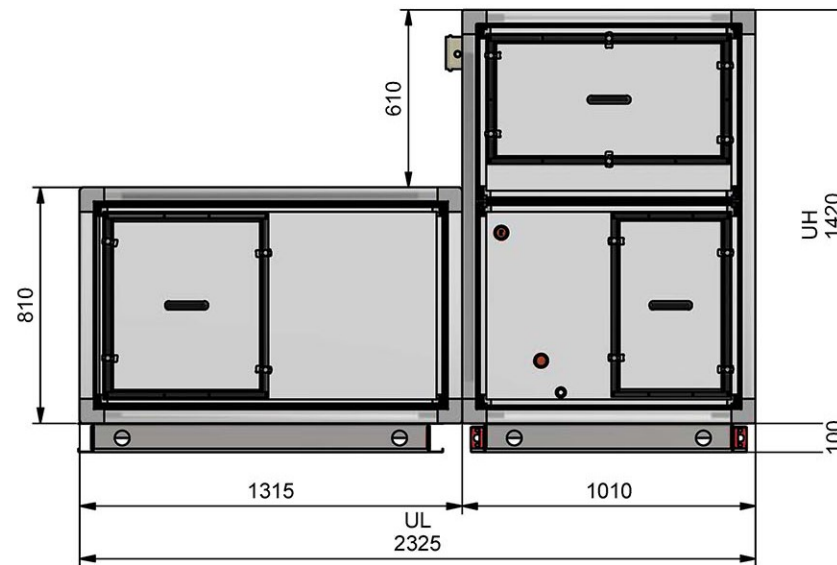
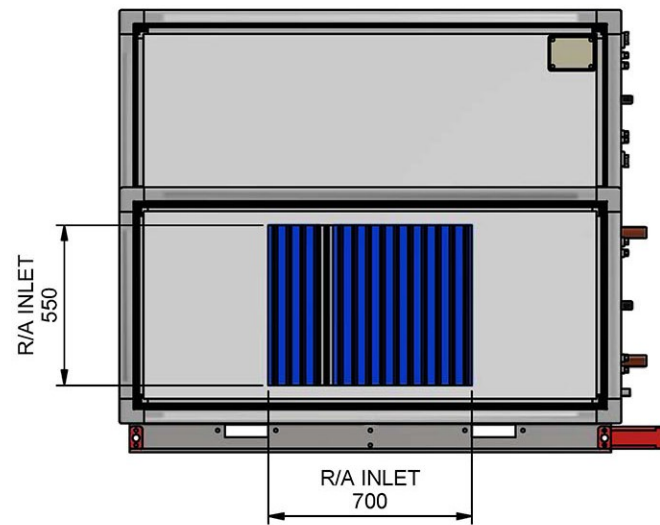
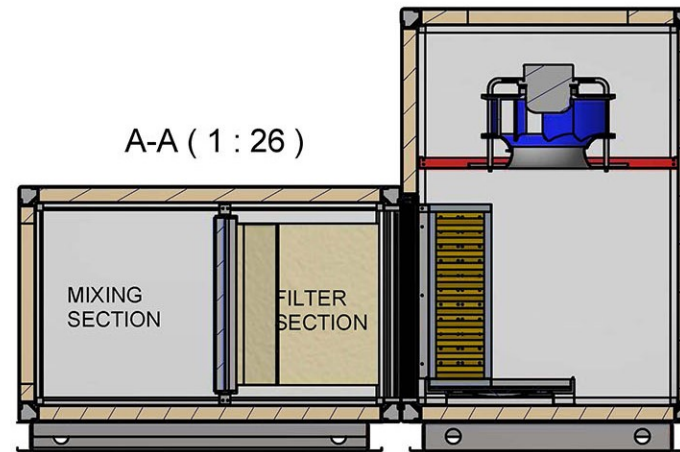

MAX R/A INLET (HORIZONTAL) : 570X1485MM
 MAX O/A INLET (VERTICAL) : 480X1485MM
 MAX S/A (HORIZONTAL) : 380X1500MM
 MAX S/A (VERTICAL) : 770X1500MM

UNLESS OTHERWISE SPECIFIED
 DIMENSIONS ARE IN MILLIMETERS
 BREAK AND DEBUR ALL SHARP EDGES

3rd ANGLE
 PROJECTION
 DO NOT SCALE DRAWING

Rev	By	Date	Description
/00	Toh	22/03/2017	Initial Released

Fantech Pty Ltd. © A.C.N. 005 434 024
 45 NESTOR DRIVE, MEADOWBROOK, QUEENSLAND, AUSTRALIA. 4131
 TELEPHONE: (07) 32 999 888 FACSIMILE: (07) 32 999 800



DRAWN: Toh DATE: 22/3/2017
 CHKED: Sean DATE: --
 APPRD: JT DATE: --

General Layout
 ME2B-V205/G3-FPL,
 GR40(115514)x1

DRAWING NO: 868-8030-2205 REV: /00 SCALE: 1 : 26 SIZE: A3